



RAYNOR



# STYLEVIEW™

C O L L E C T I O N

[WWW.RAYNOR.COM](http://WWW.RAYNOR.COM)

# STYLEVIEW™

C O L L E C T I O N

*"StyleView doors are an excellent combination of contemporary design and quality construction. The configuration options are so broad that we are able to create doors that truly complement the architectural elements of the home. They are the first option I consider for the modern home."*

Charles Stinson,  
Charles R. Stinson  
Architects -  
Deephaven, MN



An inspiration in both form and function, Raynor StyleView offers architectural flexibility, maximum visibility and extreme durability in a maintenance-free aluminum door. The Custom Profile, Wide Profile and Narrow Profile models feature a series of unprecedented designs, architectural glass options and 187 ArmorBrite™ color finishes for showcasing a home's unique flair. From modern styles to classic facades, StyleView is the choice for achieving a contemporary look or accentuating the design of an older residence.



## Glass Options

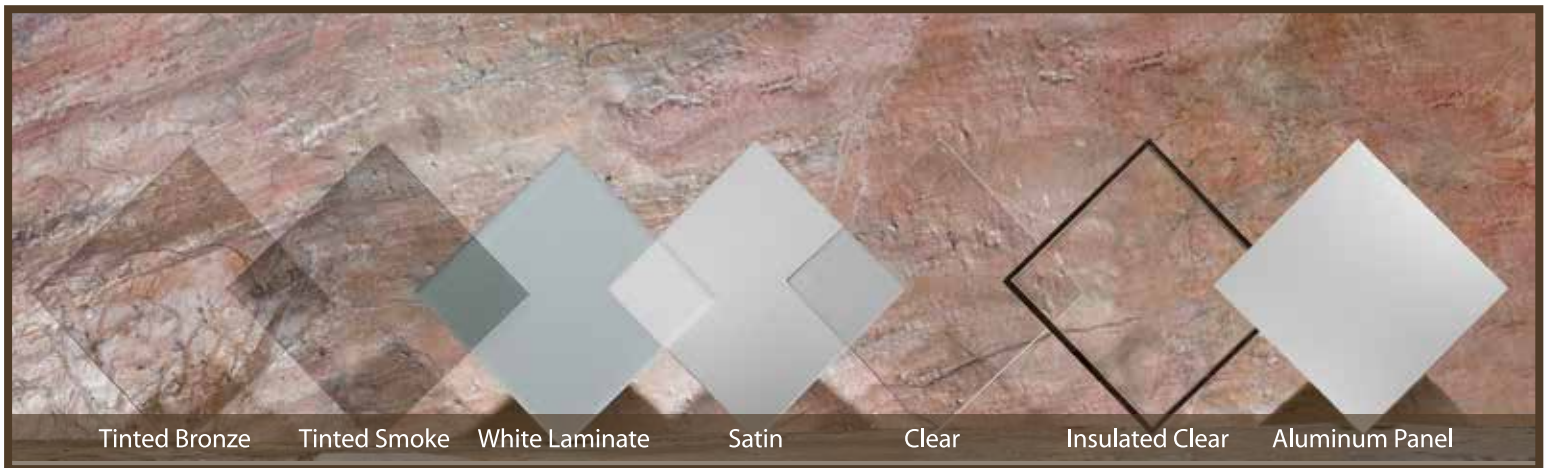

Glazing options range in thicknesses including: 1/8", 3/16", 1/4" and 1/2" insulated.

## ArmorBrite™ Color System



Choose from over 187 Raynor ArmorBrite™ colors.

For a clean, finished look and maximum protection against rust, StyleView doors are available with a powdercoated hardware system. The EnduraCote™ Hardware System features extended-life torsion springs and powdercoated hardware. Nylon rollers with steel ball bearings also help to provide superior noise reduction.



EnduraCote™ Track & Hardware

## Anodized Finish Options

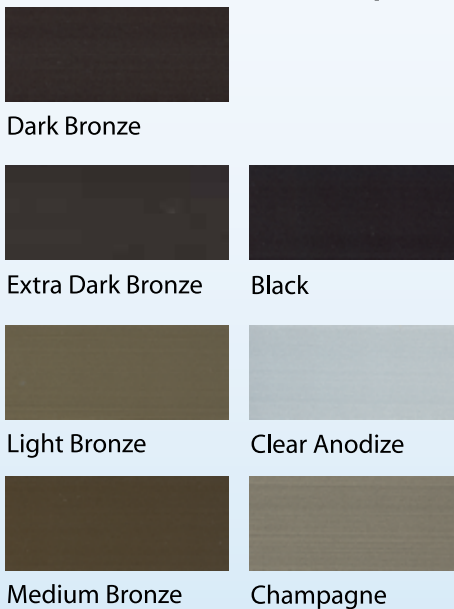

## Low-E Glass Also Available

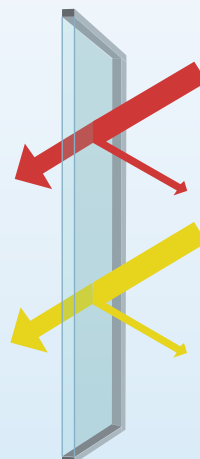

Low-e glass is the perfect solution for long-term exposure to high temperatures by allowing full visibility, while providing a barrier from the sun. Low-e glass is only available for StyleView doors with insulated glass.

## Galvanized

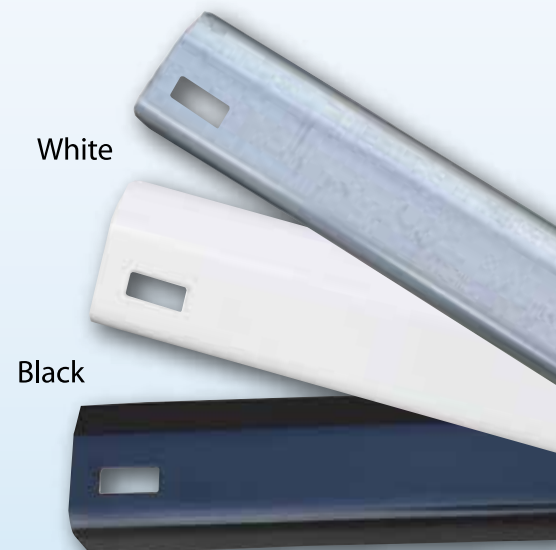

# CUSTOM CARRIAGE HOUSE



Custom Carriage House Bi-Fold, ArmorBrite beige rails, ArmorBrite matched panels, 2 over 2 tempered clear pane

StyleView Custom Profile Carriage House doors feature architectural grandeur without the maintenance concerns of a typical wood door. The Swing-Up, Swing-Out, Accordion and Bi-Fold designs can be modified to meet the aesthetics of your home by selecting from 187 ArmorBrite™ color finishes and numerous glass and batten options. And, for added style, choose between true and simulated divided lites in various pane configurations.

## CUSTOM CARRIAGE HOUSE SPECIFICATIONS

Door Width	Door Height	Section Thickness	Section Joint	Door Styles	Window Designs	Glass Thickness
4' - 20'	6' - 10'	2"	Tongue & Groove	Swing-Up, Swing-Out, Accordion, Bi-Fold	1 Pane, 2 Pane, 3 Pane, 4 Pane, 2 over 2, 3 over 3, 4 over 4, Prairie	1/8", 3/16", 1/4", 1/2"

Top Section

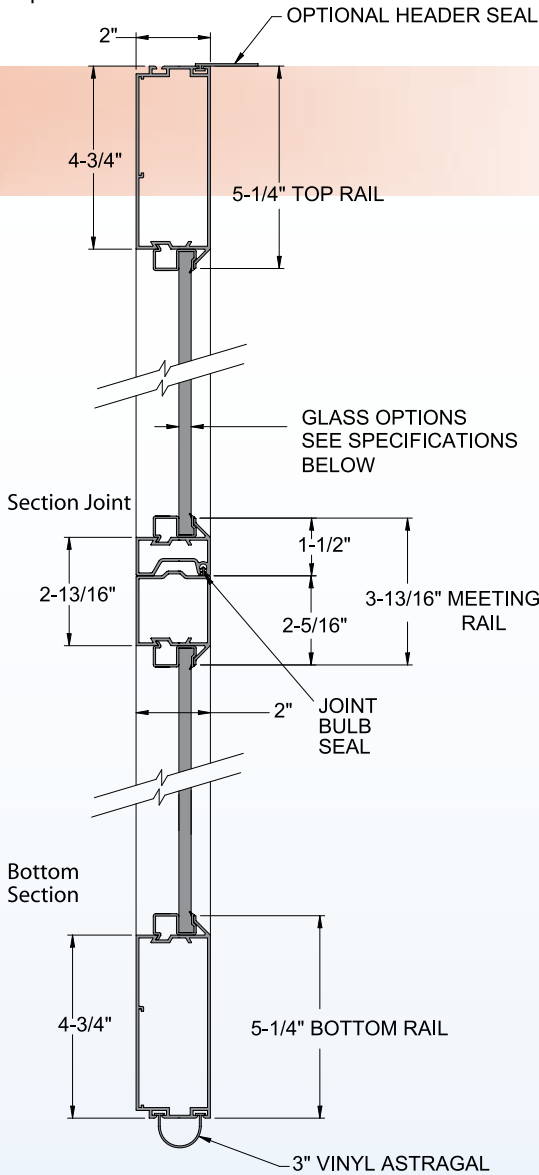

WINDOW OPTIONS

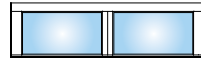

1 pane

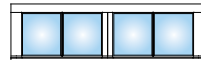

2 pane

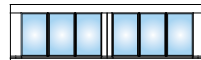

3 pane

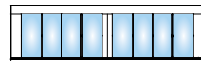

4 pane

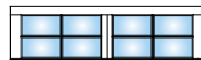

2 over 2 pane



2 over 2 pane



3 over 3 pane



4 over 4 pane



Prairie (Simulated Only)

7 feet high illustrations shown

SWING-UP



SWING-OUT

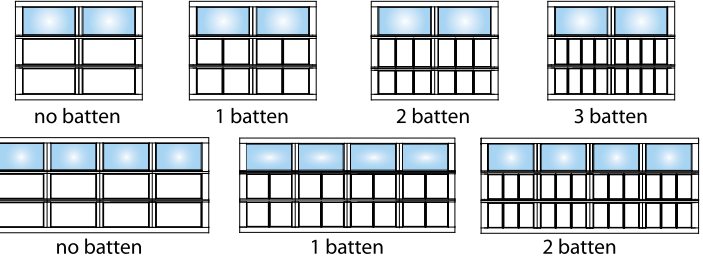

ACCORDION

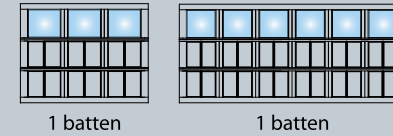

BI-FOLD

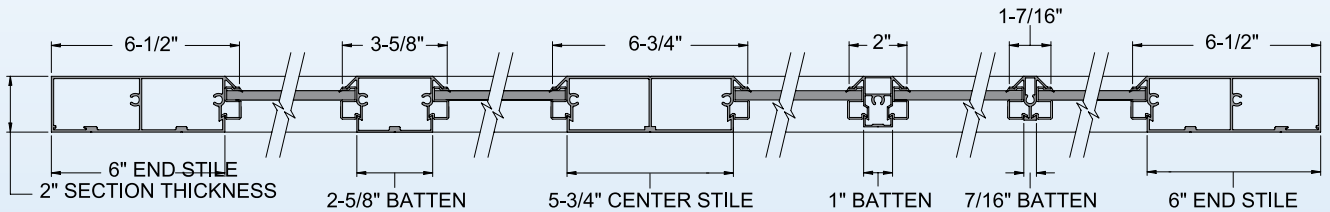
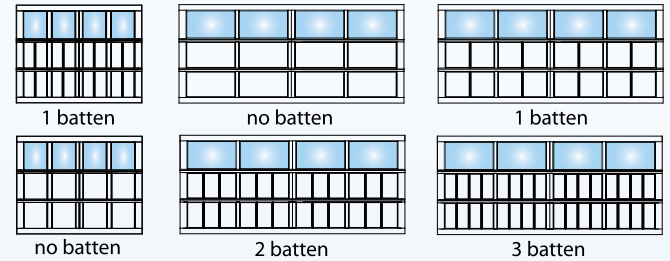

Glass Type	End Stile Width	Center Stile Width	Batten Width	Finish	Track/Hardware Finish	Limited Warranty
Clear Laminate, Acrylic, Insulated, Reflective, Tinted, Frosted, Satin	6" Wide Std	5-3/4" Std, 2-5/8" Std	7/16" Std, 1" Opt, 2-5/8" Opt	Anodize Finishes, 187 ArmorBrite Colors	Galvanized, EnduraCote White, EnduraCote Black	See Page 14

# CUSTOM MIXED PANEL



Custom Millcreek, single car with panels, ArmorBrite gray with satin glass

A perfect alternative to standard steel doors, StyleView Custom Profile Mixed Panel designs offer a distinctive look for your home. By utilizing various panel spacing options, the Mixed Panel model will differentiate your garage door from others in your neighborhood. Featuring 187 ArmorBrite™ finishes and a variety of glass options, StyleView Custom Mixed Panel doors complement the individuality of your residence.

## CUSTOM MIXED PANEL SPECIFICATIONS

Door Width	Door Height	Section Thickness	Section Joint	Door Styles	Window Designs	Glass Thickness
4' - 16'	6' - 10'	2"	Tongue & Groove	See Elevation Chart	1 Pane	1/8", 3/16", 1/4", 1/2"

Top Section

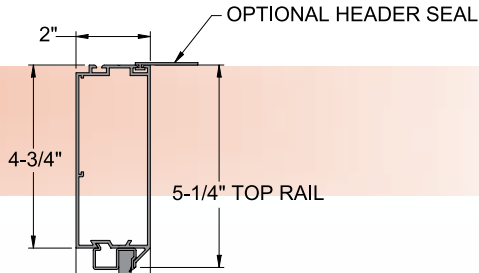

Section Joint

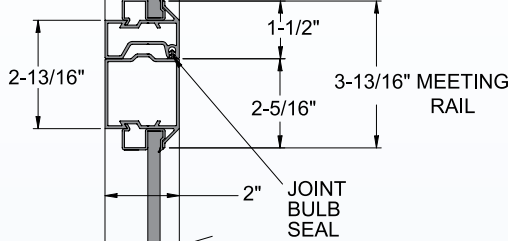

Bottom Section

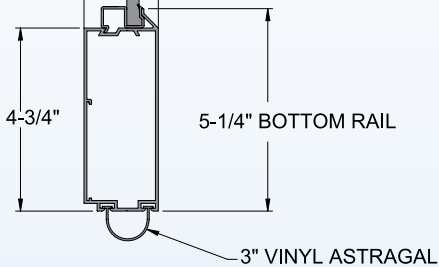

7 feet high illustrations shown

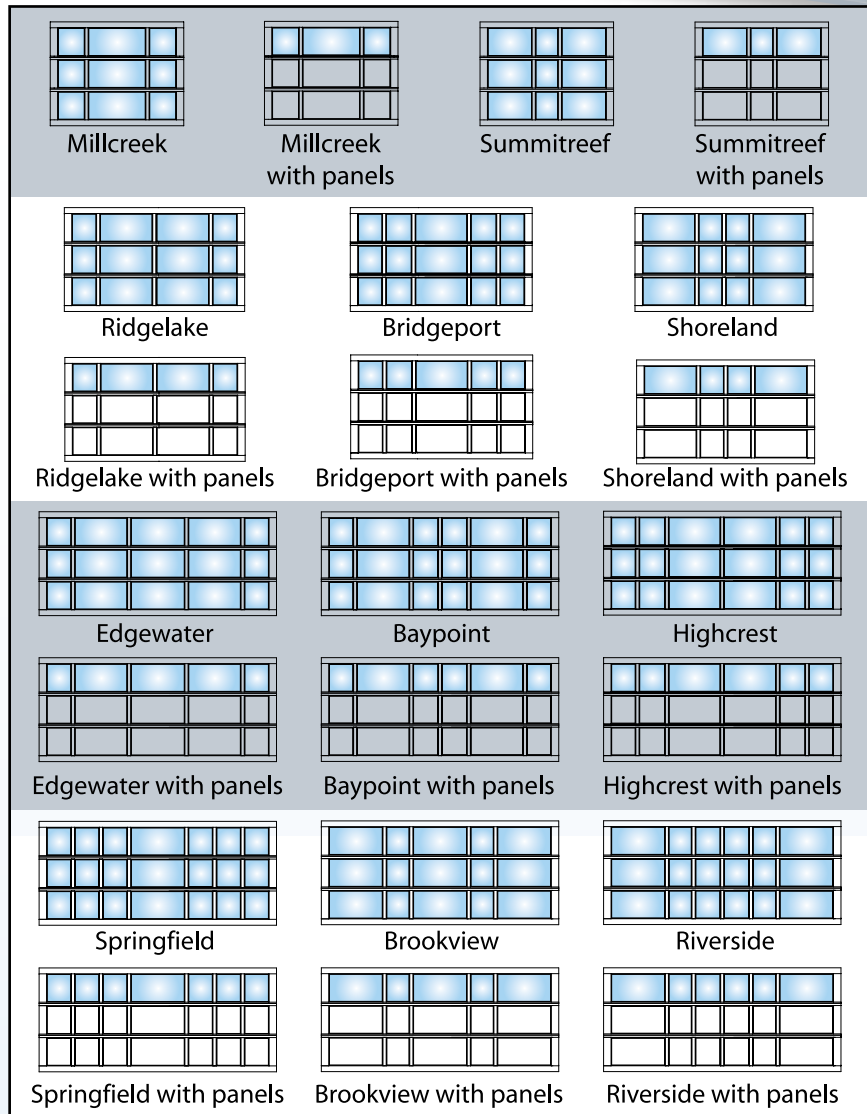

All options available with ArmorBrite color matched aluminum or glass panels.

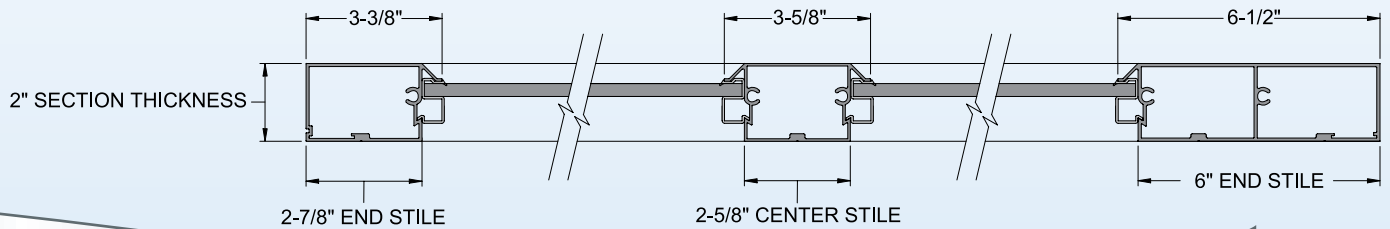

Glass Type	End Stile Width	Center Stile Width	Batten Width	Finish	Track/Hardware Finish	Limited Warranty
Clear, Laminate, Acrylic, Insulated, Reflective, Tinted, Frosted, Satin	6" Wide Std	2-5/8" Std	Not Available	Anodize Finishes, 187 ArmorBrite Colors	Galvanized, EnduraCote White, EnduraCote Black	See Page 14

# WIDE PROFILE



Wide Profile, double car, ArmorBrite white rails with 1/8" satin glass

If you are looking for a heavy-duty door that will enhance your home's panache or timeless architecture, the Wide Profile model is the answer. Designed for both strength and durability, the 2" thick Wide Profile door features rail and stile construction with a standard joint seal. This model also offers 187 ArmorBrite™ exterior finish options and optional white or black EnduraCote™ hardware. And, for added design flexibility, the Wide Profile model is also available with window thicknesses ranging from 1/8" to 1/2", in various glass types including: frosted, laminate, reflective, satin, tinted, tempered and insulated.

## WIDE PROFILE SPECIFICATIONS

Door Width	Door Height	Section Thickness	Section Joint	Door Styles	Window Designs	Glass Thickness
4' - 20'	6' - 10'	2"	Tongue & Groove	Not Available	1 Pane	1/8", 3/16", 1/4", 1/2"



Top Section

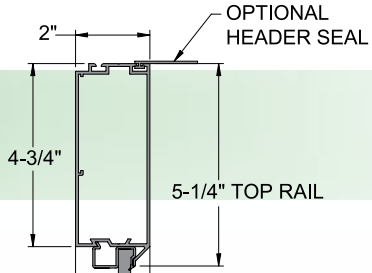

7 feet high illustrations shown

SINGLE CAR

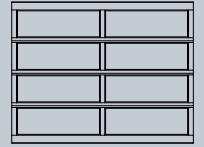

single car, 4'0" to 9'2", 2 panel design

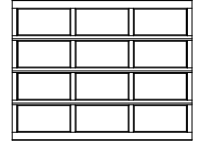
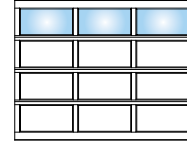
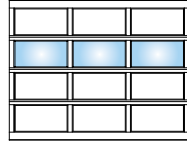
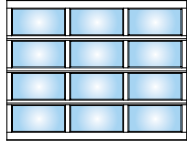

single car, 9'3" to 12'2", 3 panel design

DOUBLE CAR

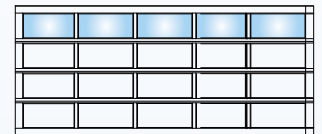
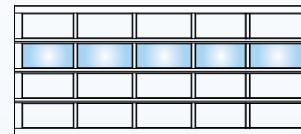
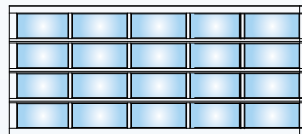
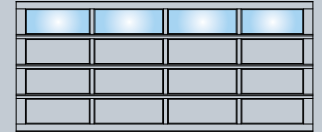
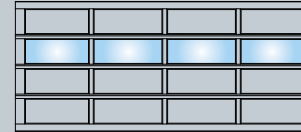

double car, 12'3" to 20'0", 4 & 5 panel designs

All options available with ArmorBrite color matched aluminum or glass panels.

Section Joint

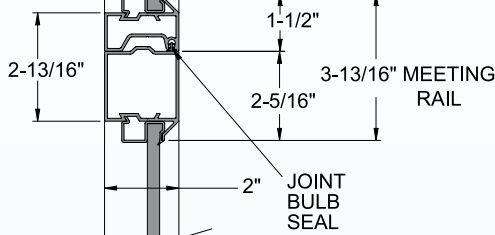

Bottom Section

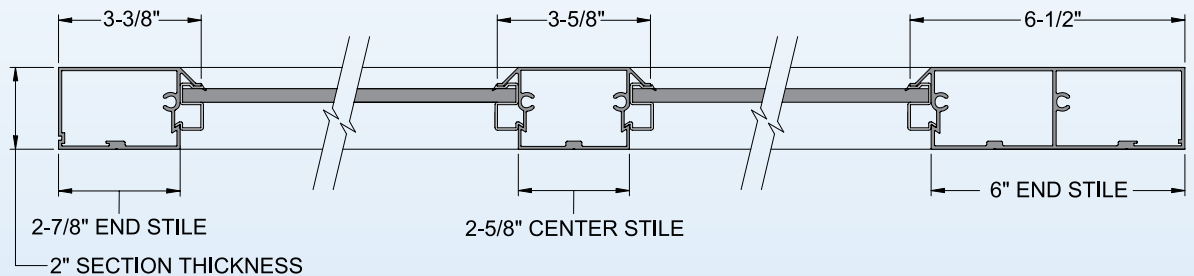
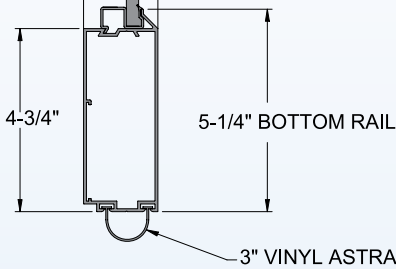

Glass Type	End Stile Width	Center Stile Width	Batten Width	Finish	Track/Hardware Finish	Limited Warranty
Clear, Laminate, Acrylic, Insulated, Reflective, Tinted, Frosted, Satin	2-7/8" Std, 6" Wide Opt	2-5/8" Std	Not Available	Anodize Finishes, 187 ArmorBrite Colors	Galvanized, EnduraCote White, EnduraCote Black	See Page 14

# NARROW PROFILE



Narrow Profile, single car, ArmorBrite white rails with 1/8" tempered black glass

Accented with a streamlined design, the Narrow Profile model is a 1-3/4" thick door with a ship lap section joint and standard joint seal. This model is a maintenance-free solution for your garage door needs with 187 ArmorBrite™ exterior finishes and optional white or black EnduraCote™ hardware. In addition, Narrow Profile doors feature architectural variation with multiple glass options for contemporary and traditional styles alike. The offering includes thicknesses ranging from 1/8" tempered to 1/2" insulated in various glass types, including frosted, laminate, reflective and tinted.

## NARROW PROFILE SPECIFICATIONS

Door Width	Door Height	Section Thickness	Section Joint	Door Styles	Window Designs	Glass Thickness
4' - 16'	6' - 10'	1-3/4"	Ship-Lap	Not Available	1 Pane	1/8", 3/16", 1/4", 1/2"

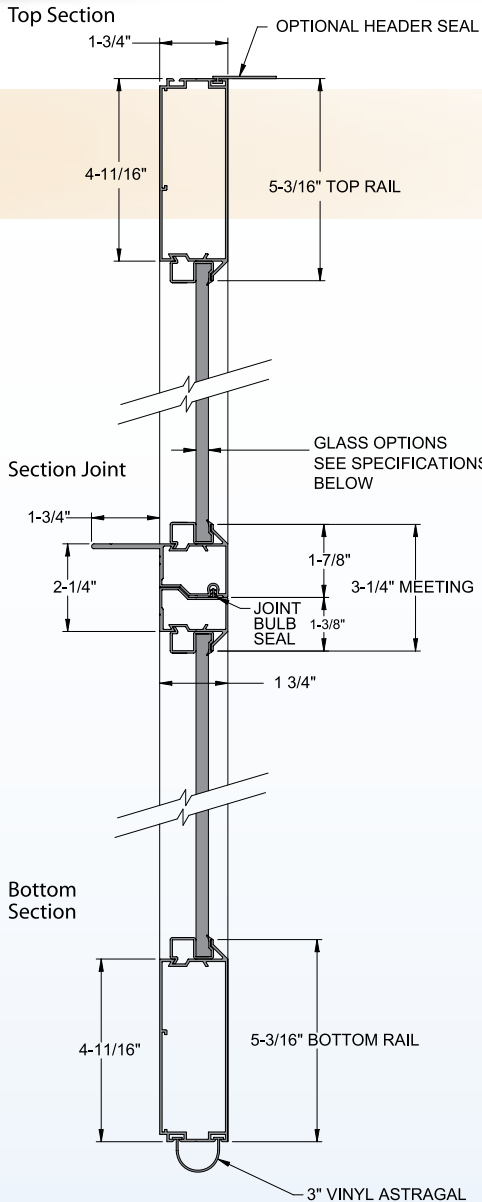

7 feet high illustrations shown

**SINGLE CAR**

single car, 4'0" to 9'2", 2 panel design

single car, 9'3" to 12'2", 3 panel design

**DOUBLE CAR**

double car 12'3" to 16'0", 4 & 5 panel designs

All options available with ArmorBrite color matched aluminum or glass panels.

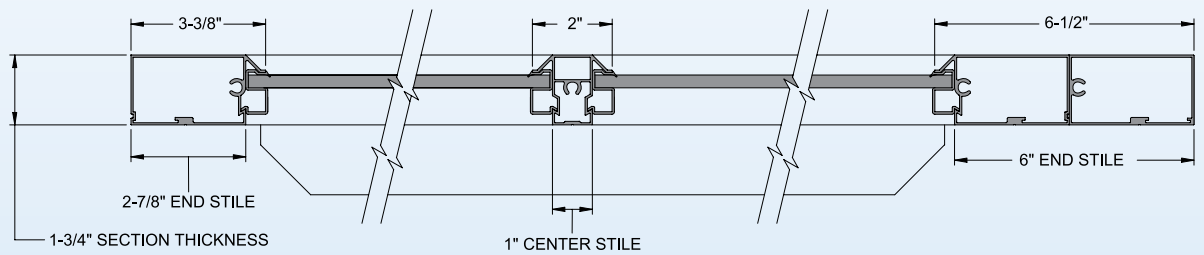

Glass Type	End Stile Width	Center Stile Width	Batten Width	Finish	Track/Hardware Finish	Limited Warranty
Clear, Laminate, Acrylic, Insulated, Reflective, Tinted, Frosted, Satin	2-7/8" Std, 6" Opt	1" Std	Not Available	Anodize Finishes, 187 ArmorBrite Colors	Galvanized, EnduraCote White, EnduraCote Black	See Page 14

## StyleView™ Limited Warranty\*

### Door Sections:

Raynor warrants StyleView door sections against defects in material and workmanship, for the original purchaser, for "As Long As You Own Your Home."

### Window Components:

Window components are warranted against defects in material and workmanship for three (3) years from the date of delivery to the original purchaser.

### EnduraCote™ Hardware & Springs:

Raynor warrants all EnduraCote hardware and spring components against defects in material and workmanship, for the original purchaser, for "As Long As You Own Your Home."

### ArmorBrite™:

Raynor warrants StyleView™ sections painted with ArmorBrite powdercoat finishes against cracking or peeling for five (5) years from the date of delivery to the original purchaser.

### Galvanized Hardware & Springs:

Raynor warrants all galvanized hardware for six (6) years and spring components for three (3) years against defects in material and workmanship from the date of delivery to the original purchaser.

*\*Full limited warranty details are available at: [www.raynor.com/products](http://www.raynor.com/products)*

## Raynor Prodigy - Offering Space-Saving Operation

### DC Motor, Jackshaft Operation

Raynor Prodigy offers an exceptional solution for StyleView garage doors. StyleView doors provide full-view capabilities and the Prodigy opener ensures your garage door opener won't clutter the view. It mounts easily on the wall beside the garage door and comes with a remote 2-port, 100-watt light that can be positioned anywhere in the garage.

Each unit comes standard with a 3-button premium remote control with rolling code security technology, Smart Control Panel™ and 200 watts of lighting for brighter illumination.

Limited Lifetime Motor Warranty - 5 Year Parts



## Raynor Ultra - The Perfect Match for Your Door

### 3/4 Horsepower, Chain Operation

Designed to handle even the heaviest StyleView doors, the Raynor Ultra combines a 3/4 hp motor with a rugged I-beam rail and chassis support for added strength and reliable operation. A dual-drive sprocket allows the opener's speed to be adjusted to optimize door and opener performance.

Each unit comes standard with a 3-button premium remote control with rolling code security technology, Smart Control Panel™ and 200 watts of lighting for brighter illumination.

Limited Lifetime Motor Warranty - 5 Year Parts.



# RAYNOR®

1-800-4-RAYNOR (472-9667)

Raynor Worldwide

P.O. Box 448, 1101 East River Road

Dixon, IL 61021-0448

[WWW.RAYNOR.COM](http://WWW.RAYNOR.COM)